

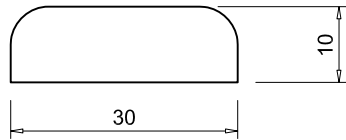

COPRIFILI E SCURETTI INTERNI

WWW.PAVANELLOSERRAMENTI.IT



CORNICE ESTERNA STANDARD

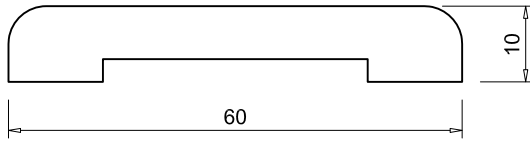

CORNICE INTERNA STANDARD

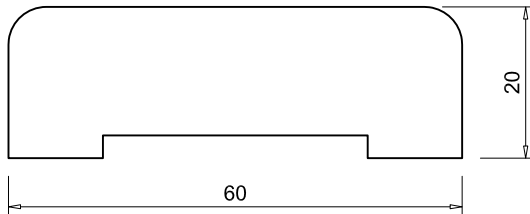

CORNICE INTERNA PER MONOBLOCCO AVVOLGIBILE

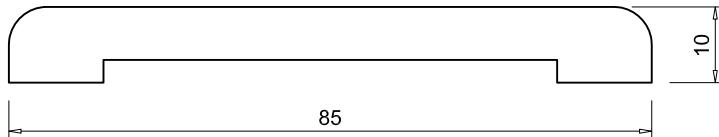

CORNICE INTERNA PER MONOBLOCCO AVVOLGIBILE LIGHT

**ANGOLARI E PIATTINE ESTERNI IN ALLUMINIO PER SERRAMENTI IN LEGNO / ALLUMINIO
MISURE STANDARD:**

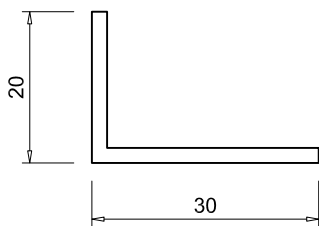

A 20 X 30 X 2

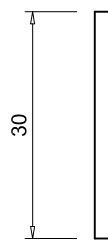

P 30 X 2

	COPRIFILI								2			
									1			
									0	Prima emissione	01 - 08 - 2016	G M
ST/0	CATALOGO TECNICO (technical manual)								n°rev.	Natura modifica	Data modifica	Stgla
Quote in mm	<3	<6	<30	<120	<400	<1000	<2000	<4000	Pag. 8 . 1		Tutti i diritti sul presente disegno sono riservati DIVIETO DI RIPRODUZIONE SENZA AUTORIZZAZIONE	
Tolleranze generali ISO 2768 - v (vedi a destra)	-	±0.5	±1.0	±1.5	±2.5	±4.0	±6.0	±8.0	Scala disegno 1 : 1			

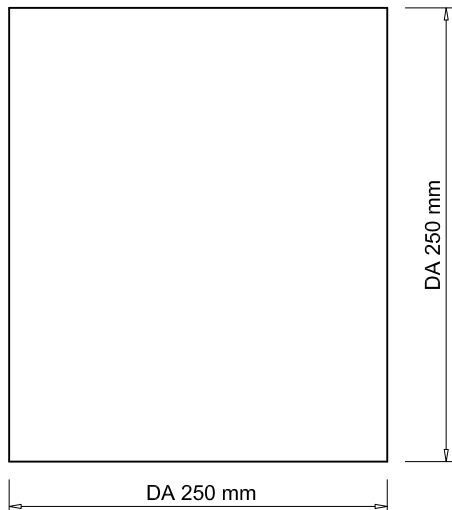

SCURETTO LISCIO

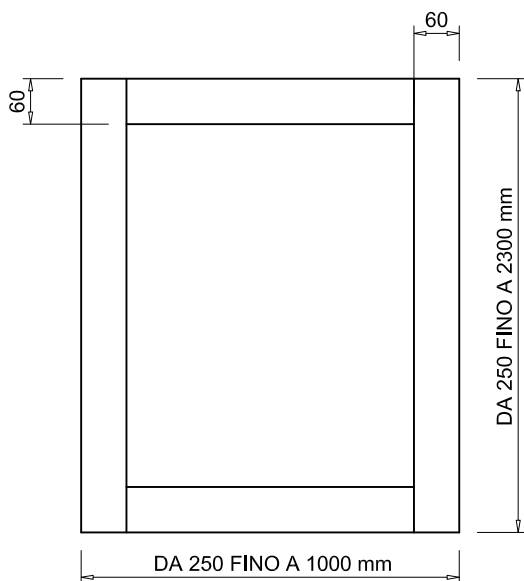

**SCURETTO LISCIO
INTELAIATO**

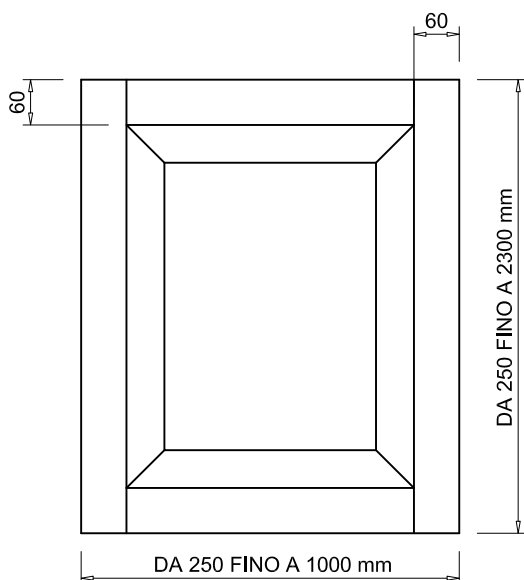

**SCURETTO BUGNATO
INTELAIATO**



**TIPOLOGIA PER
SCURETTI INTERNI**

2			
1			
0	Prima emissione	01 - 01 - 2015	G M
n°rev.	Natura modifica	Data modifica	Stgla

ST/0

CATALOGO TECNICO (technical manual)

Tutti i diritti sul presente disegno sono riservati
DIVIETO DI RIPRODUZIONE
SENZA AUTORIZZAZIONE

Quote in mm
Tolleranze generali ISO 2768 - v
(vedi a destra)

<3	<6	<30	<120	<400	<1000	<2000	<4000
-	±0.5	±1.0	±1.5	±2.5	±4.0	±6.0	±8.0

Scala disegno 10 : 1

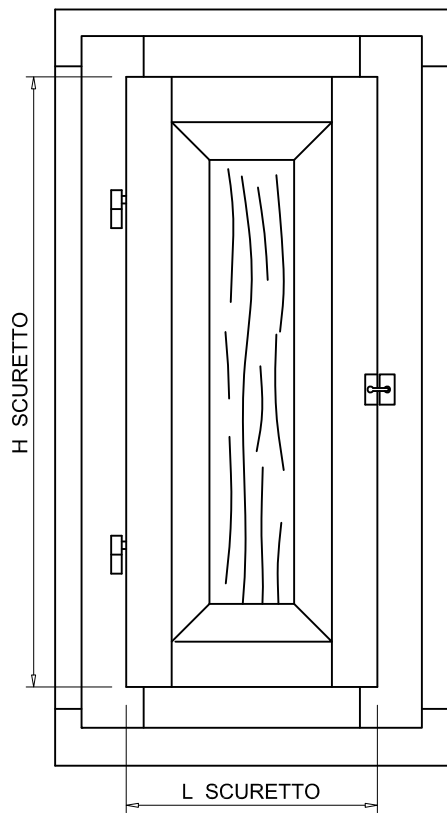
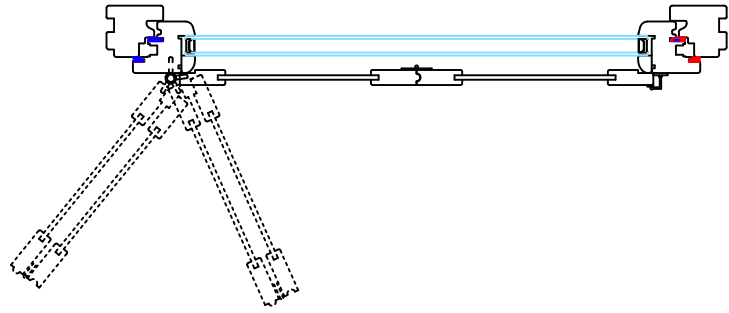

SCURETTO 1 ANTA

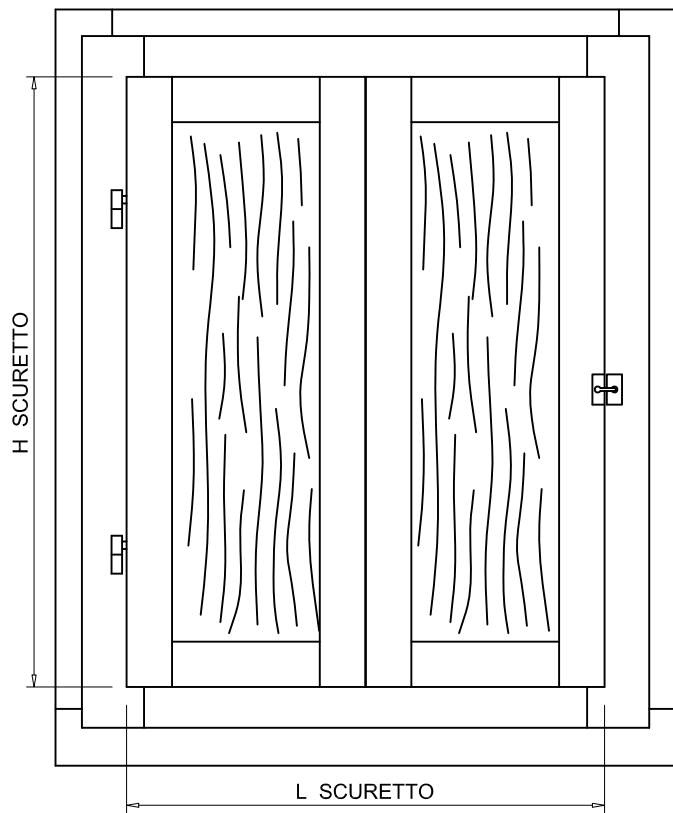

**SCURETTO 1 ANTA
RIPIEGHEVOLE**



**TIPOLOGIA DI APERTURA
DEGLI SCURETTI**

2			
1			
0	Prima emissione	01 - 01 - 2015	G M
n°rev.	Natura modifica	Data modifica	Stgla

ST/0

CATALOGO TECNICO (technical manual)

Quote in mm

<3 <6 <30 <120 <400 <1000 <2000 <4000

Pag. 8 . 3

Tolleranze generali ISO 2768 - v
(vedi a destra)

- ±0.5 ±1.0 ±1.5 ±2.5 ±4.0 ±6.0 ±8.0

Scala disegno 10 : 1

Tutti i diritti sul presente disegno
sono riservati
**DIVIETO DI RIPRODUZIONE
SENZA AUTORIZZAZIONE**

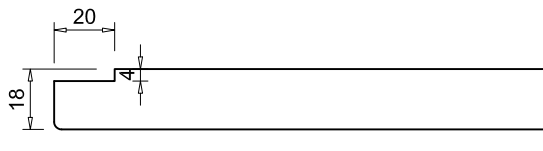
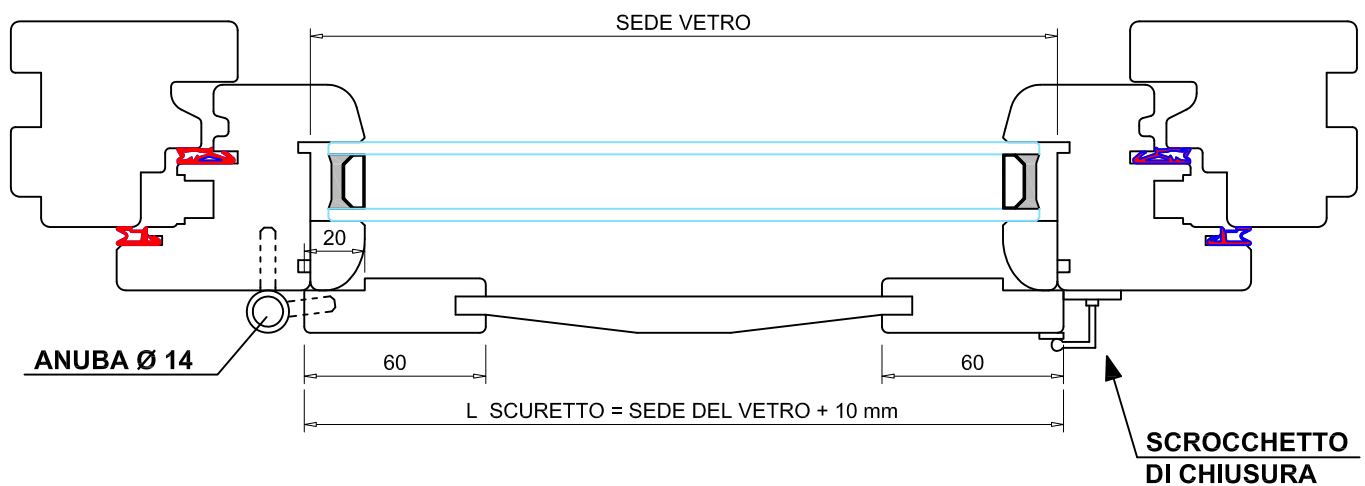

SCURETTO LISCIO

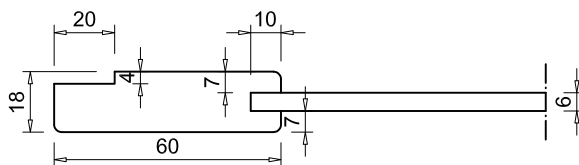

SCURETTO LISCIO INTELAIATO

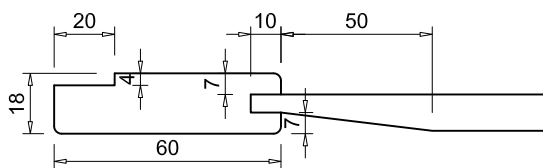

SCURETTO BUGNATO INTELAIATO

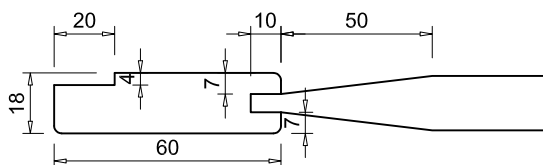

SCURETTO BUGNATO INTELAIATO 2 LATI



TIPOLOGIA E POSIZIONAMENTO DELLO SCURETTO

2			
1			
0	Prima emissione	01 - 01 - 2015	G M
n°rev.	Natura modifica	Data modifica	Stgla

ST/0

CATALOGO TECNICO (technical manual)

Quote in mm	<3	<6	<30	<120	<400	<1000	<2000	<4000
Tolleranze generali ISO 2768 - v (vedi a destra)	-	±0.5	±1.0	±1.5	±2.5	±4.0	±6.0	±8.0